

PART NR.
DTM06-2S

COUNTRY OF ORIGIN
China

STANDARDS
REACH and RoHS compliant
Flammability: UL94 V-0
Protection: IP68, IP6K9K

CHARACTERISTICS

- With grommet and wedge lock
- To be used with size 20 terminals, max 7,5A

PHOTO / TECHNICAL DRAWING

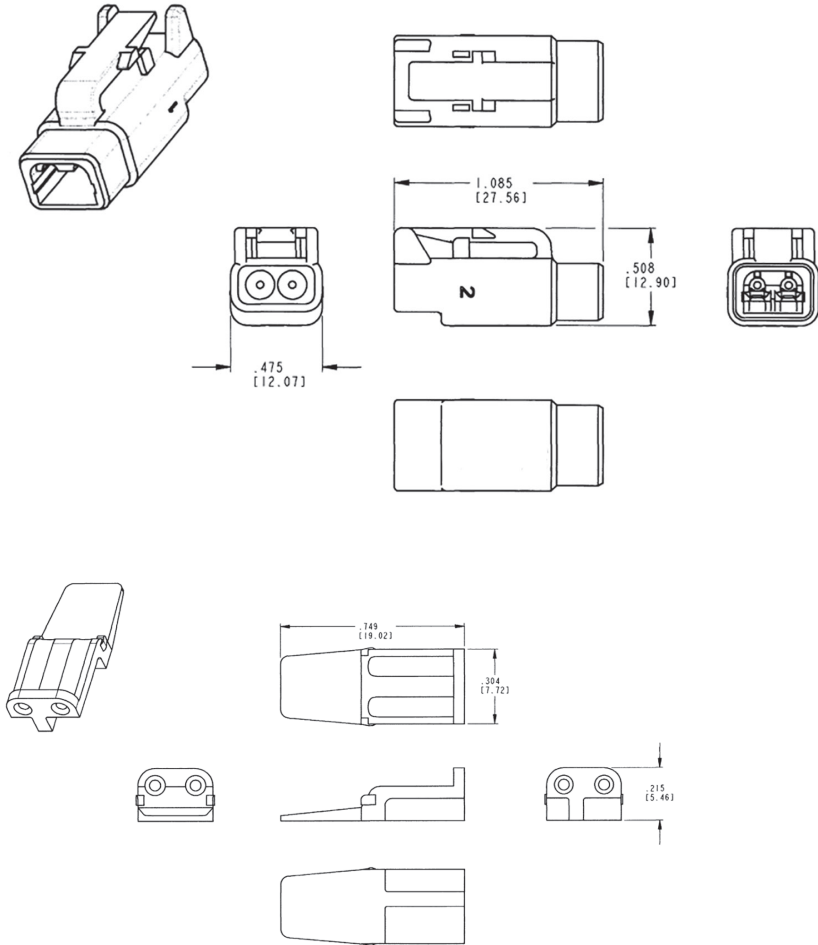

DIMENSIONS

L x W x H:

27,56 x 12,07 x 12,90 mm (housing)
19,02 x 7,72 x 5,46 mm (wedge lock)

TECHNICAL SPECIFICATIONS

Housing: PA66 GF15, grey
Grommet: VMQ silicone, burnt red
Wedge lock: PBT, orange
Temperature range: -55~125 °C
Max. current rating: 7,5A